

Support du doublet de Lhéris

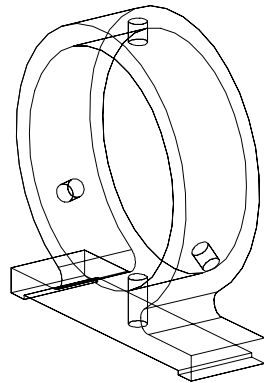

SUPPORT PRINCIPAL OMEGA

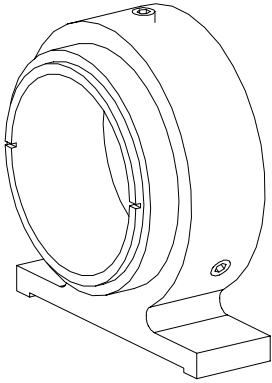
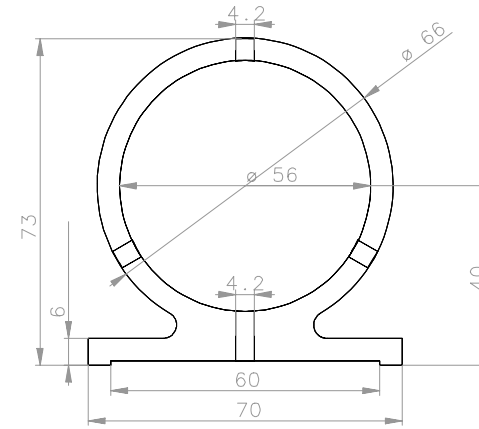
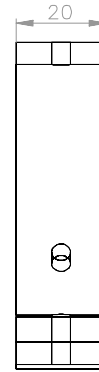

Bague coulissante de mise au point

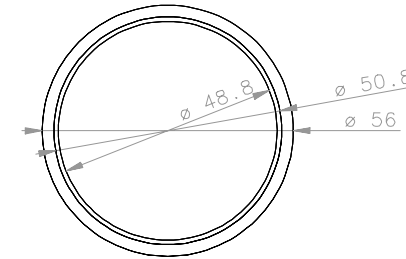
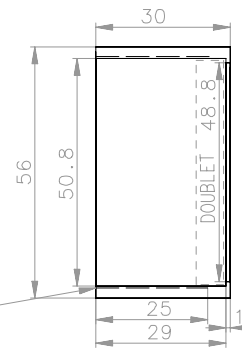
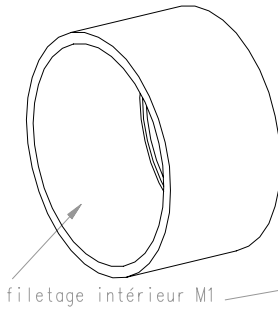

filetage intérieur M1

Bague vissante de bloquage du doublet

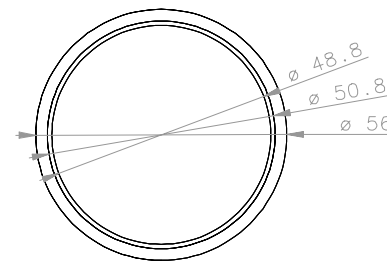
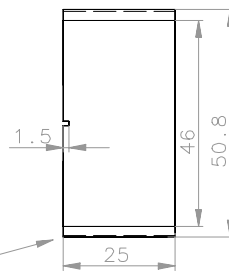
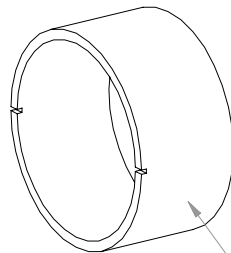

Filetage extérieur M1