

Support du doublet de Lhéris

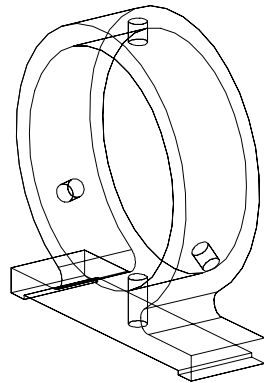

SUPPORT PRINCIPAL OMEGA

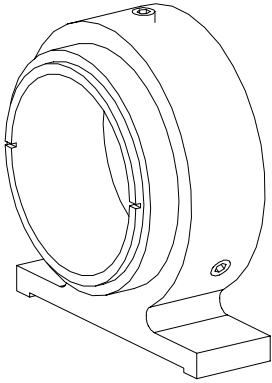
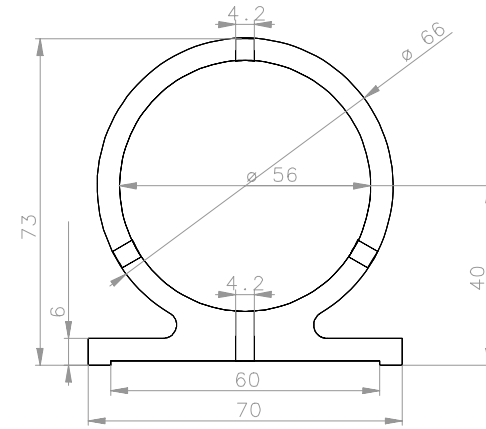
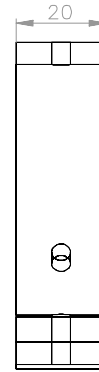

Bague coulissante de mise au point

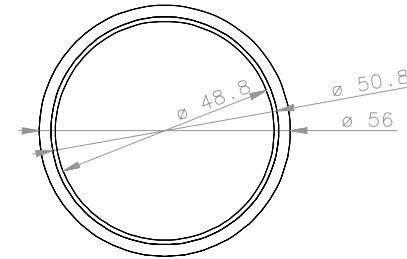
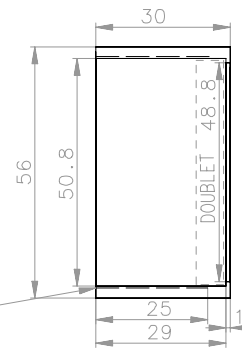
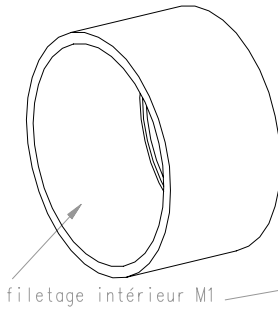

Bague vissante de bloquage du doublet

