

Note v1.0 and v2.0 only differ by pcb shape & case, and regulator used

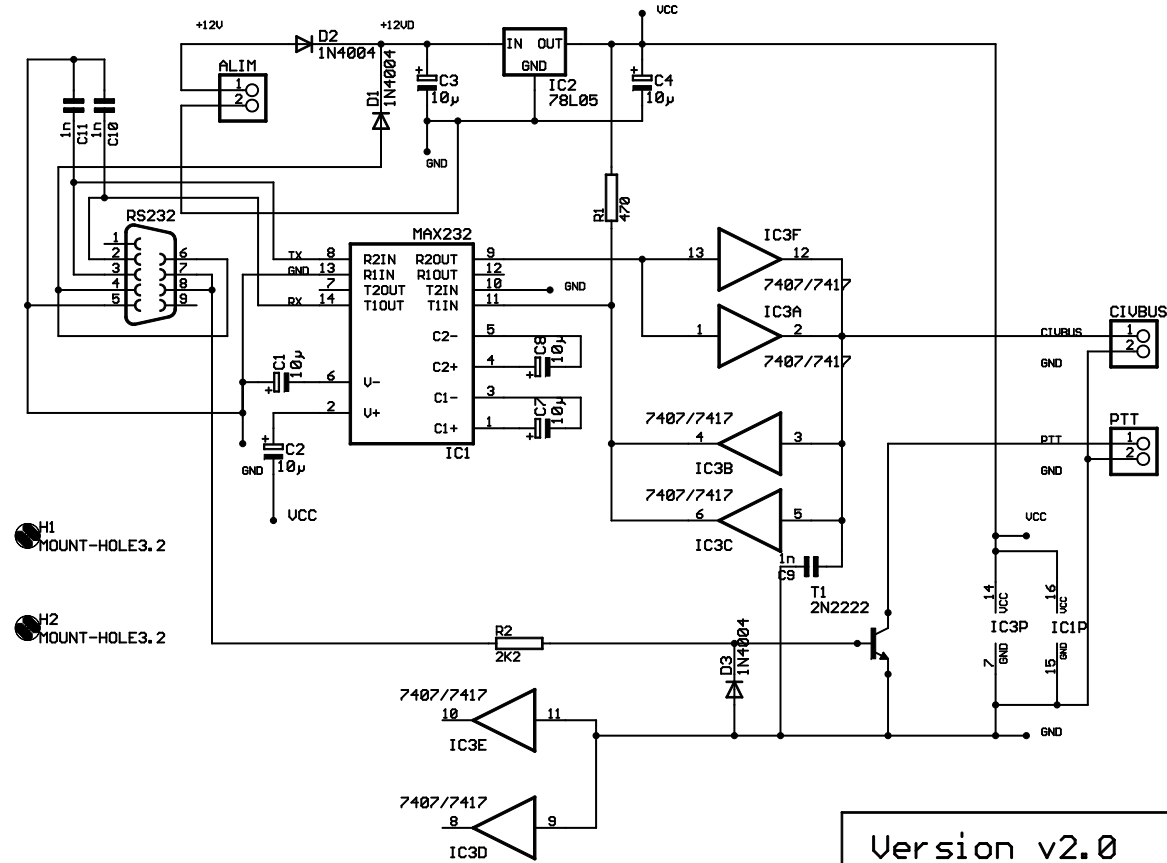

Version v2.0	
TITLE: ICOMCI-V	
Document Number:	REV:
Date: 12/12/2008 21:16:04	Sheet: 1/1